

ROBERTS

Play10

DAB / DAB+ / FM RDS digital portable radio



DAB
Digital Audio Broadcasting

DAB+

**Digital
Radio**

Please read this manual before use

Contents

<i>Controls</i>	2-3	<i>System reset</i>	20
<i>Battery operation</i>	4	<i>Headphone socket</i>	21
<i>Using the AC adaptor</i>	5	<i>Dimmer function</i>	21
<i>Operating your radio - DAB</i>	6	<i>General</i>	22
<i>Selecting a station - DAB</i>	7	<i>Specifications</i>	22
<i>Secondary services - DAB</i>	7	<i>Circuit features</i>	22
<i>Display options - DAB</i>	8-9	<i>Guarantee</i>	<i>Back page</i>
<i>Finding new stations - DAB</i>	9		
<i>Manual tuning - DAB</i>	10		
<i>Dynamic range control - DAB</i>	11		
<i>Prune stations - DAB</i>	12		
<i>Operating your radio - FM</i>	13		
<i>Manual tuning - FM</i>	14		
<i>Display options - FM</i>	15		
<i>Scan sensitivity setting - FM</i>	16		
<i>Presetting stations</i>	17		
<i>Recalling a preset station</i>	17		
<i>Software version</i>	18		
<i>Language function</i>	19		

Controls

(Top)

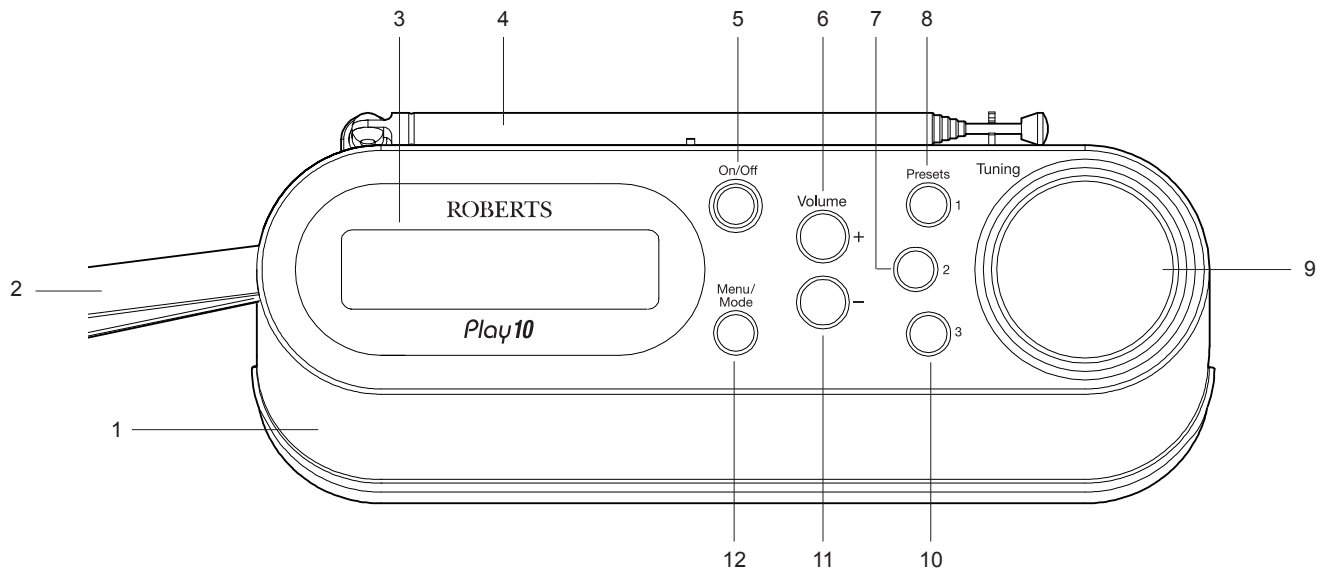

1. Loudspeaker
2. Carry strap
3. LCD display
4. Telescopic aerial
5. On / Off button
6. Volume Up button

7. Preset 2 button
8. Preset 1 button
9. Tuning / Select control
10. Preset 3 button
11. Volume Down button
12. Menu / Mode button

Controls

(Left hand side)

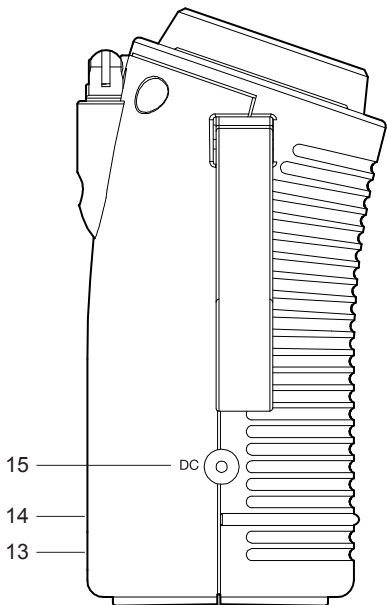

- 13. Battery compartment
- 14. USB upgrade socket (in battery compartment, for service use only)
- 15. DC input socket

(Right hand side)

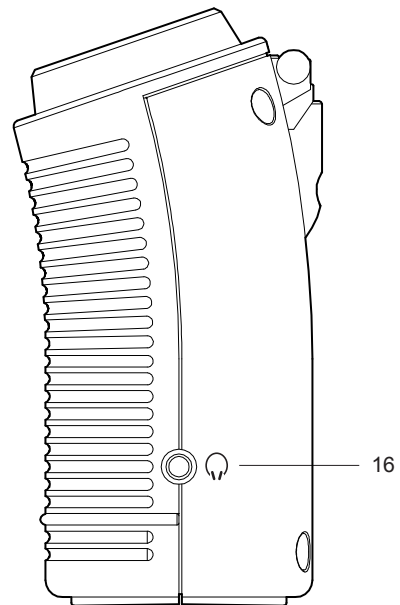

- 16. Headphone socket

Battery operation

1. Remove the battery cover on the back of the unit by sliding the cover downwards.
2. Insert four LR6 (AA size) batteries into the spaces in the compartment. Take care to ensure all batteries are inserted with the correct polarity as shown inside the battery compartment. Replace the battery cover.
3. Reduced power, distortion and a 'stuttering' sound are all signs that the batteries may need replacing.
4. If the radio is not to be used for any extended period of time it is recommended that the batteries are removed from the radio.

We would recommend for economy that the radio is used via the AC adaptor whenever possible with battery operation for occasional use only.

IMPORTANT: The batteries should not be exposed to excessive heat such as sunshine, fire or the like. After use, disposable batteries should if possible be taken to a suitable recycling centre. On no account should batteries be disposed of by incineration.

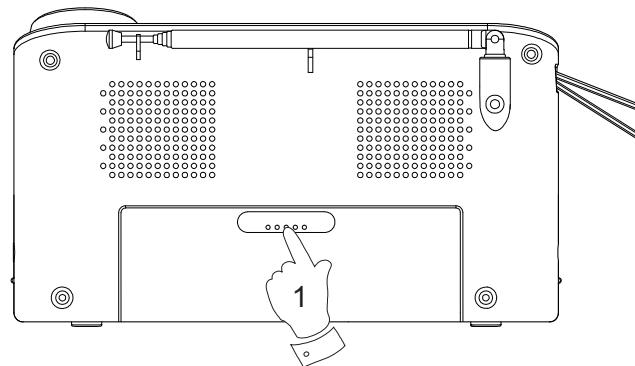

Using the AC adaptor

1. Place your radio on a flat surface.
2. Plug the mains adaptor into the DC input socket located on the left hand side of your radio (marked 'DC') ensuring that the plug is pushed fully into the socket.
3. Plug the other end of the mains adaptor into a standard mains socket outlet and switch on the wall socket. Whenever the adaptor is used the batteries are automatically disconnected.

The AC adaptor should be disconnected from the mains supply and from the radio when not in use.

IMPORTANT: The mains adaptor is used as the means of connecting the radio to the mains supply. The mains socket used for the radio must remain accessible during normal use. In order to disconnect the radio from the mains completely, the mains adaptor should be removed from the mains socket outlet completely.

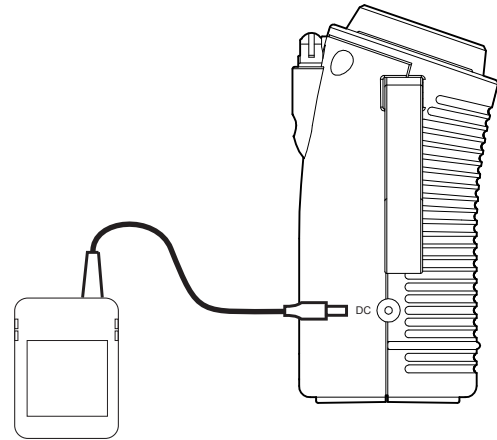

Operating your radio - DAB

1. Carefully extend the telescopic aerial. The aerial should be fully extended and positioned vertically for optimum reception.
 2. Press and release the **On/Off** button to switch on your radio. The display will show 'WELCOME' for a few seconds. After each use the radio will remember the mode used and then switch on in that mode the next time that it is used.
 3. If this is the first time the radio is used a scan of the Band III DAB channels will be carried out. This is known as 'Auto tune'. If the radio has been used before the last used station will be selected.
 4. During Auto tune each group of stations will be detected and the station count will be updated.
 5. When the Auto tune is completed the first station (in numeric-alpha order 0...9...A...Z) will be selected. The first station in the list of stations found will be played.
 6. If no stations are found then 'OFF AIR' will be displayed and it may be necessary to relocate your radio to a position giving better reception. You should then carry out an auto tune to find stations as described on page 9 (see *Finding new stations* on page 9).
- Your radio has an indicator γ on the display to indicate the strength of the DAB radio signal being received.
- Note:** When first switched on, the radio will set the volume to a moderately high level, in case the broadcast is very quiet. After you have set the volume, the radio will remember the setting that you have applied for the next time that it is used.



Selecting a station - DAB

1. Press and release the **On/Off** button to switch on your radio.
2. If you are listening in FM mode, **press and hold** the **Mode** button. 'DAB' will show on the display.
3. Rotate the **Tuning/Select** control to step through the list of available stations.
4. When the desired station name appears on the display the radio will automatically select the station after several seconds. Alternatively press and release the **Tuning/Select** control to select the station. The radio will select the new station.
5. Adjust the **Volume** to the required setting.

Note: If after selecting a station the display shows 'OFF AIR' it may be necessary to relocate your radio to a position giving better reception.

Menu/
Mode



Tuning

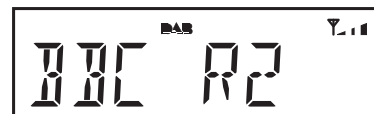
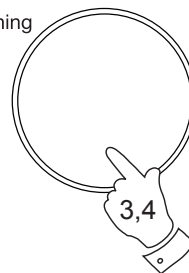

Secondary services - DAB

1. Certain radio stations have one or more secondary services associated with them. If a station has a secondary service associated with it the secondary service will then appear immediately after the primary service as you rotate the **Tuning/Select** control clockwise.
2. To tune to the secondary service, press and release the **Tuning/Select** control. Most secondary services do not broadcast continually and if the selected service is not available, the radio will re-tune to the associated primary service.

Tuning

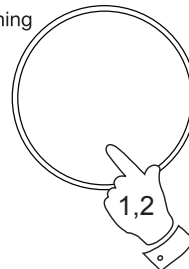

Display options - DAB

Your radio has a range of display options when in DAB mode:-

1. Press and release the **Tuning/Select** control to cycle through the various options.
 - a. Station name Displays the station name being listened to.
 - b. Scrolling text Displays scrolling text messages such as artist/track name, phone in number, etc.
 - c. Program type Displays type of station being listened to e.g. Pop, Classic, News, etc.
 - d. Signal strength Displays the signal strength. The minimum signal marker (!) shows the minimum signal strength needed for good DAB reception. The signal indicator chevrons increase or decrease showing the changing signal strength as you adjust the telescopic aerial or your radio position.
 - e. Multiplex Name Displays name of multiplex to which the current station belongs.
 - f. Frequency Displays the frequency for the currently tuned DAB station.

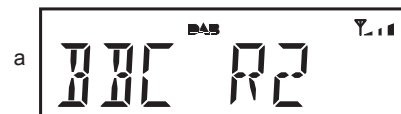
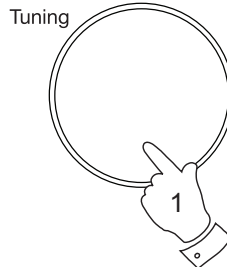

Display options - DAB cont.

g. Bit rate Displays the digital bit rate for the currently tuned DAB station.



h. Time Displays the current time.



i. Date Displays the current date.



Finding new stations - DAB

As time passes new stations may become available or you may have moved to a different part of the country. In this case you may need to cause your radio to scan for new stations.

1. **Press and hold the *Tuning/Select* control.** Your radio will perform a scan of the Band III DAB channels. As new radio stations are found the station counter on the right-hand side of the display will increase and the radio stations will be added to the list stored in the radio.

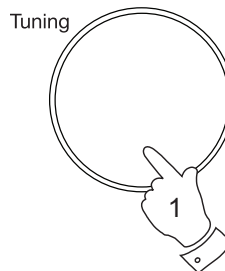

Manual Tuning - DAB

Manual tuning allows you to tune your radio to a particular DAB frequency in Band III. Any new stations found will be added to the station list. This function can also be used to assist the positioning of the aerial or the radio to optimise reception for a specific channel or frequency.

1. If you are listening in FM mode, **press and hold** the **Mode** button. 'DAB' will show on the display.
2. Press and release the **Menu** button. The DAB menu will show on the display.
3. Rotate the **Tuning/Select** control until the display shows 'MANUAL'. Press and release the **Tuning/Select** control to enter the manual tune mode.
4. Rotate the **Tuning/Select** control to select the desired DAB channel. Press and release the **Tuning/Select** control to tune to the chosen frequency.
5. If a signal is present, this will be indicated on a signal strength display. The minimum signal marker (!) shows the minimum signal strength needed for good DAB reception. The signal indicator chevrons increase or decrease showing the changing signal strength as you adjust the telescopic aerial or your radio position.
6. When a DAB signal is found, as shown by the signal indicator chevrons, any new radio stations found with this signal will be added to the list stored in the radio.
7. Press and release the **Menu** button to be able to manually tune to a different frequency. Alternatively, press and release the Menu button a second time in order to return to the normal playing mode.

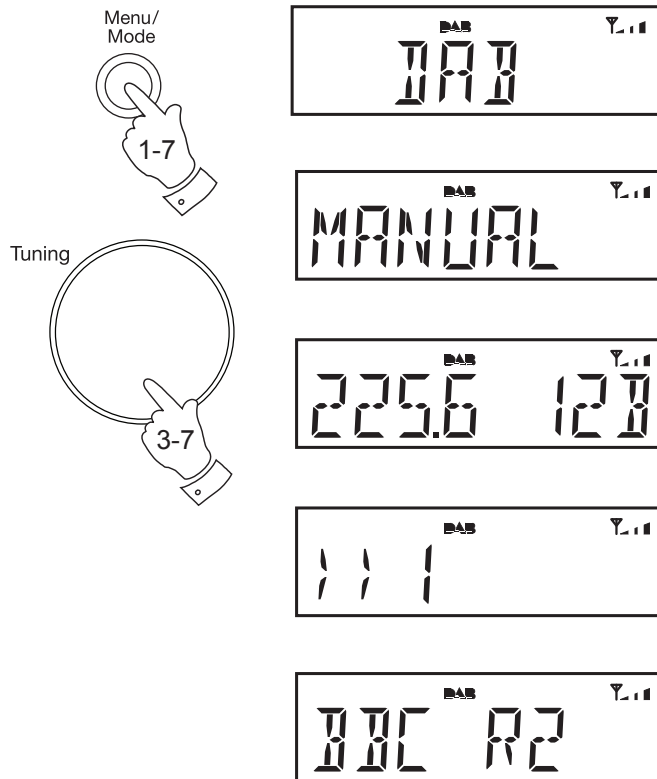

Dynamic Range Control (DRC) settings - DAB

The DRC facility can make quieter sounds easier to hear when your radio is used in a noisy environment.

1. Press and release the **On/Off** button to switch on your radio.
2. If you are listening in FM mode, **press and hold** the **Mode** button. 'DAB' will show on the display.
3. Press and release the **Menu** button. The DAB menu will show on the display.
4. Rotate the **Tuning/Select** control until 'DRC' shows on the display.
5. Press and release the **Tuning/Select** control to enter adjustment mode.
6. Rotate the **Tuning/Select** control to select required DRC setting (default is 0).
 - DRC 0 DRC is switched off, Broadcast DRC will be ignored.
 - DRC 1/2 DRC level is set to 1/2 that sent by broadcaster.
 - DRC 1 DRC is set as sent by broadcaster.
7. Press and release the **Tuning/Select** control to confirm the setting. The display will return to the station name display after several seconds.

On/Off



Menu/
Mode



Tuning

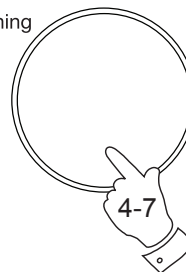

Note: Not all DAB broadcasts use the DRC function. If the broadcast does not provide DRC information, then the DRC setting in the radio will have no effect.

Prune stations - DAB

If you move to a different part of the country, some of the stations which were listed may no longer be available. Also, from time to time, some DAB services may stop broadcasting, or may change location or frequency. Stations which cannot be found, or which have not been received for a very long time are shown in the station list with a question mark.

The Prune stations function will delete the marked DAB stations from your station list.

1. Press and release the **On/Off** button to switch on your radio.
2. If you are listening in FM mode, **press and hold** the **Mode** button. 'DAB' will show on the display.
3. Press and release the **Menu** button. The DAB menu will show on the display.
4. Rotate the **Tuning/Select** control until 'PRUNE' shows on the display.
5. Press and release the **Tuning/Select** control. 'SELECT' will show on the display.
6. Press and release the **Tuning/Select** control to cause the invalid station names to be removed from the station list. The display will return to station name display after several seconds.

If you do not wish to prune stations press the **Menu** button to return to the previous display.

Note: If you have moved your radio to a different part of the country you should also carry out a search for new stations (please see the section 'Finding new stations' on page 9).

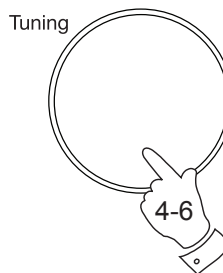

Operating your radio - FM

1. Carefully extend the telescopic aerial. The aerial should be fully extended and positioned vertically for optimum reception.
2. Press and release the **On/Off** button to switch on your radio.
3. If you are listening in DAB mode, **press and hold** the **Mode** button. 'FM' will show on the display.
4. Rotate the **Tuning/Select** control clockwise and then immediately press and hold the **Tuning/Select** control for several seconds. Your radio will scan in an upwards direction (low frequency to high frequency) and stop automatically when it finds a station of sufficient strength.
5. After a few seconds the display will update. The display will show the frequency of the signal found. If the signal is strong enough and there is RDS data present then the radio will display the station name.
6. Rotate the **Tuning/Select** control anti-clockwise and then immediately press and hold the **Tuning/Select** control for several seconds. Your radio will scan the FM band in a downwards direction (high frequency to low frequency).
7. When the waveband end is reached your radio will recommence tuning from the opposite waveband end.
8. Adjust the **Volume** to the required setting.
9. To switch off your radio press and release the **On/Off** button.

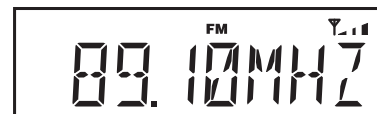
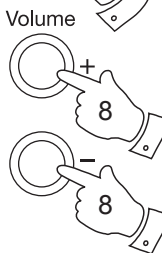
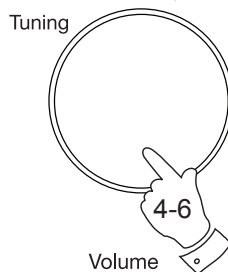

Manual tuning - FM

1. Carefully extend the telescopic aerial. The aerial should be fully extended and positioned vertically for optimum reception.
2. Press and release the **On/Off** button to switch on your radio.
3. If you are listening in DAB mode, **press and hold** the **Mode** button. 'FM' will show on the display.
4. Rotate the **Tuning/Select** control to tune to a station. The frequency will change in steps of 50kHz. If the radio is tuned to a station of sufficient signal strength with RDS information present, then the display may change to show the station name.
5. When the waveband end is reached the radio will recommence tuning from the opposite waveband end.
6. Adjust the **Volume** to the required setting.
7. To switch off your radio press and release the **On/Off** button.

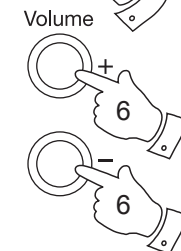
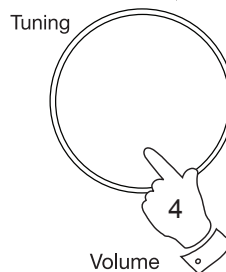
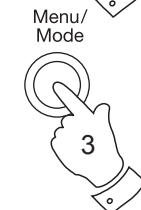

Display options - FM

Your radio has a range of display options for FM mode:-

The Radio Data System (RDS) is a system in which inaudible digital information is transmitted in addition to the normal FM radio programme. RDS offers several useful features. The following are available on your radio.

1. Press and release the **Tuning/Select** control to cycle through the various options.

- | | |
|-------------------|--|
| a. Station name | Displays the name of the station being listened to. |
| b. Scrolling text | Displays scrolling text messages such as artist/track name, phone in number etc. |
| c. Program Type | Displays type of station being listened to e.g. Pop, Classic, News, etc. |
| d. Frequency | Displays frequency of the station currently being listened to. |
| e. Time | Displays the current time. |
| f. Date | Displays the current date. |

Note: If no RDS information is available, the radio will be unable to display the station name, scrolling text and programme type information. Your radio will display 'NO TEXT' if there is no scrolling text and 'NO PTY' if there is no programme type information.

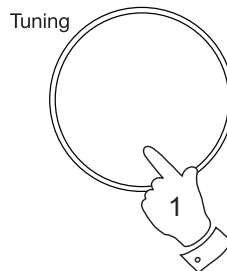

Scan sensitivity setting - FM

Your radio will normally scan for FM broadcasts which are strong enough to give good reception. However, you may wish the Auto-scan function to also be able to find weaker signals, possibly from more distant radio transmitters. Your radio includes a local / distant option for the Auto-scan function.

1. Press and release the **On/Off** button to switch on your radio. Ensure your radio is in FM mode.
2. Press and release the **Menu** button. The FM menu will show on the display.
3. Rotate the **Tuning/Select** control until 'SETTING' shows on the display. Press and release the **Tuning/Select** control to enter the scan settings menu.
4. Rotate the **Tuning/Select** control to switch between 'LOCAL' and 'DISTANT' options. The Distant option will allow the radio to find weaker signals when scanning.
5. Press and release the **Tuning/Select** control to confirm your selection. The display will return to the radio display after several seconds. The Local or Distant setting is stored in the radio and remains in force until changed or until a System Reset.

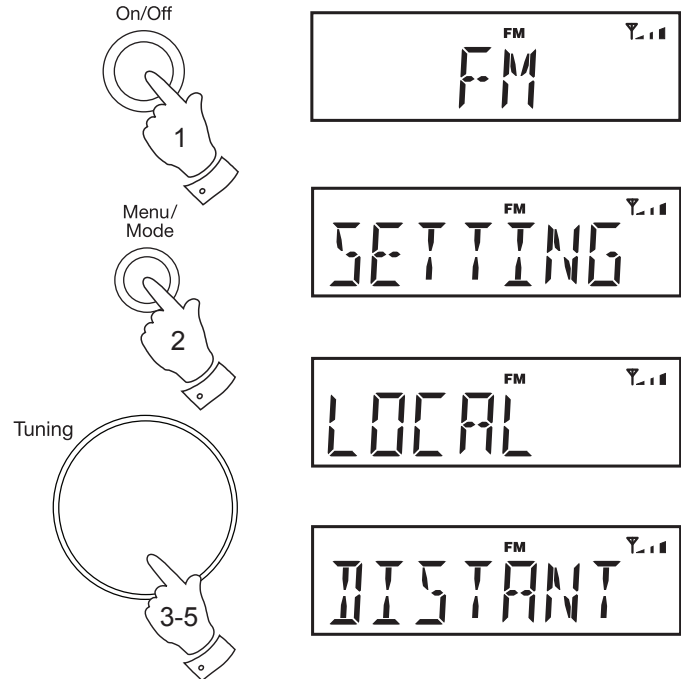

Note: The initial setting (out of the box, or after a System Reset) causes the radio to ignore weaker (or more distant) signals.

Presetting stations

You may store your preferred DAB and FM radio stations to the preset station memories. There are 6 memory presets in your radio, 3 for DAB and 3 for FM. Presets are remembered by your radio in the event of a power failure. The procedure for setting presets and using them to tune to stations is the same for FM and DAB modes and is described below.

1. Press and release the **On/Off** button to switch on the radio.
2. Select the desired waveband and tune to the required station as previously described.
3. **Press and hold** the required **Preset** button until the display shows, for example, 'P1 SAVED'. The currently tuned station will be stored under the chosen preset button. Repeat this procedure for the remaining presets as needed.
4. Stations which have been stored in preset memories may be overwritten by following the above procedure.



Recalling a preset station

1. Press and release the **On/Off** button to switch on the radio.
2. Select the required waveband as previously described.
3. Press and release the required **Preset** button. Your radio will tune to the station stored in preset memory.
 - The display will show 'EMPTY' if no station has been stored to that preset.

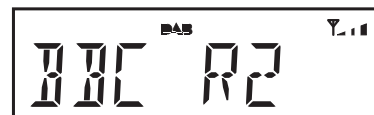

Software version

The software version display cannot be altered and is just for your reference.

1. Press and release the **On/Off** button to switch on the radio.
2. Press and release the **Menu** button. The main menu will show on the display.
3. Rotate the **Tuning/Select** control until 'SYSTEM' appears on the display. Press and release the **Tuning/Select** control.
4. Rotate the **Tuning/Select** control until 'SW VER' appears on the display. Press and release the **Tuning/Select** control to display the software version.
5. Repeatedly, press and release the **Menu** button to return to the normal radio display.

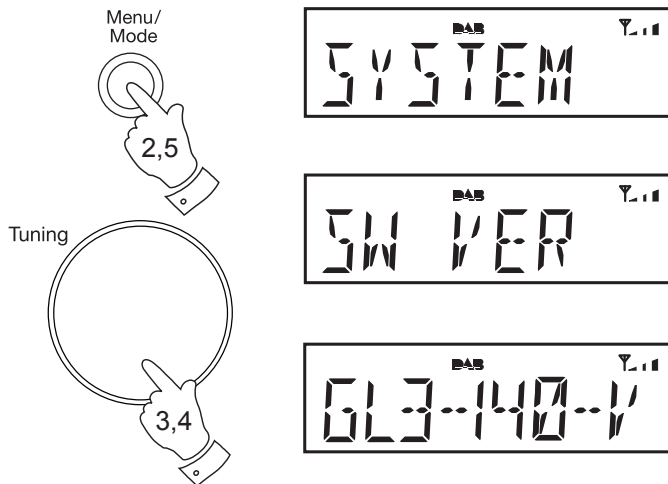

Language function

Your radio's menus can be configured to a different language.

1. Press and release the **On/Off** button to switch on the radio.
2. Press and release the **Menu** button. The main menu will show on the display.
3. Rotate the **Tuning/Select** control until 'SYSTEM' appears on the display. Press and release the **Tuning/Select** control.
4. Rotate the **Tuning/Select** control until 'LANGUAGE' appears on the display. Press and release the **Tuning/Select** control to enter the language adjustment menu.
5. Rotate the **Tuning/Select** control until your desired language appears on the display.
6. Press and release the **Tuning/Select** control to confirm your choice. The display will change to the chosen language.

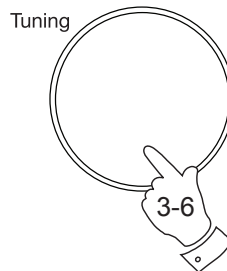
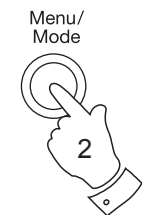

System reset

If your radio fails to operate correctly, or some digits on the display are missing or incomplete carry out the following procedure.

1. Press and release the **On/Off** button to switch on the radio.
2. Press and release the **Menu** button. The main menu will show on the display.
3. Rotate the **Tuning/Select** control until 'SYSTEM' appears on the display. Press and release the **Tuning/Select** control.
4. Rotate the **Tuning/Select** control until 'FACTORY' appears on the display. Press and release the **Tuning/Select** control. 'RESET' will show on the display.
5. Press and release the **Tuning/Select** control.
6. A full reset will be performed. The station list and presets will be erased. The display will show 'RESTART' then 'WELCOME' and after a few seconds a station scan search will be performed automatically. The display will show the progress of the station search. The number on the right of the display is the number of stations that have been found.

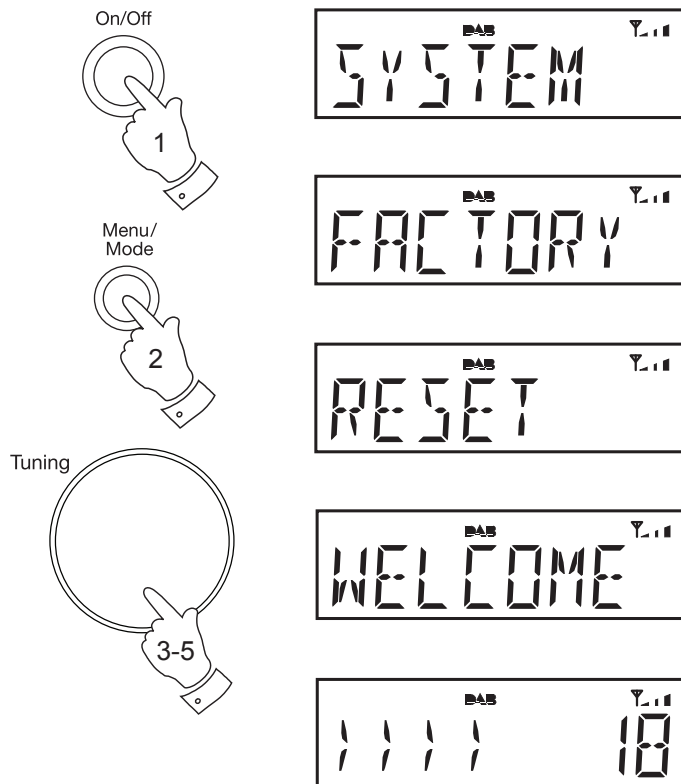

In the event of a malfunction due to electrostatic discharge, mains power supply transients or short interruptions, reset the product as above to resume normal operation. If you are not able to perform the reset operation as above, removal and reconnection of the power supply and batteries may be required.

Headphone socket

A 3.5mm **Headphone Socket** located on the right hand side of your radio is provided for use with either headphones or an earpiece. Inserting a plug automatically mutes the internal loudspeaker.

Please be aware that the sensitivity of headphones can vary widely. We therefore recommend setting the volume to a low level before connecting headphones to the radio.

IMPORTANT: Excessive sound pressure from earphones and headphones can cause hearing loss.

The headphone socket is compatible with stereo and mono headphones but the audio will always be heard as mono.



To prevent possible hearing damage, do not listen at high volume levels for long periods.

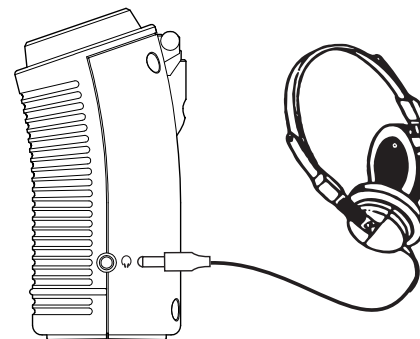

Dimmer function

The brightness of the display can be adjusted. If you use the unit in a bedroom, you may prefer a lower brightness level than the standard setting. The dimmer can be set to Low or a High setting.

1. Press and release the **On/Off** button to switch on the radio.
2. Press and release the **Menu** button. The main menu will show on the display.
3. Rotate the **Tuning/Select** control until 'SYSTEM' appears on the display. Press and release the **Tuning/Select** control.
4. Rotate the **Tuning/Select** control until 'DIMMER' shows on the display. Press and release the **Tuning/Select** control to enter the dimmer settings.
5. To adjust the brightness rotate the **Tuning/Select** control and choose either the Low or High setting. Press and release the **Tuning/Select** control to set the desired level. The backlight will change at this time.

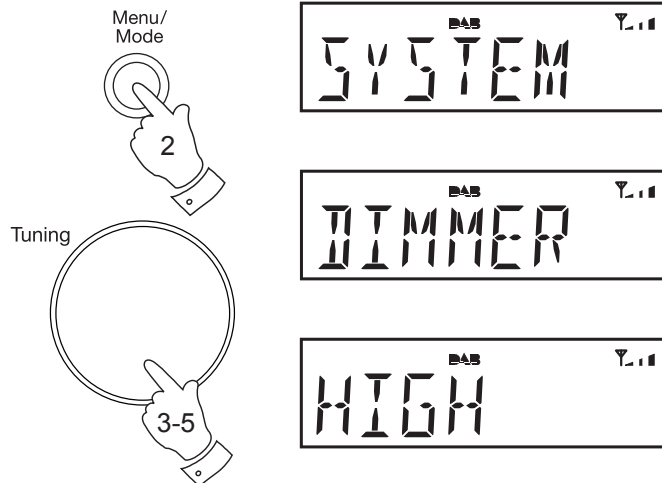

General

Do not allow this radio to be exposed to water, steam or sand. Do not leave your radio where excessive heat could cause damage such as in a parked car where the heat from the sun can build up even though the outside temperature may not seem too high. It is recommended that the DAB band be used wherever possible as better results in terms of quality and freedom from interference will usually be obtained than on the FM band.



The name plate is located on the back of your radio.

Specifications

Power Requirements

Mains AC 100 ~ 240 volts, 50/60Hz (adaptor)
Batteries 4 x LR6 (AA size)

Battery Life

Up to 30 hours using alkaline cells depending upon volume and operating mode.

Frequency Coverage

FM 87.5-108MHz
DAB 174.928 - 239.200MHz

- Your radio and AC/DC adaptor should not be exposed to dripping or splashing and no objects filled with liquids, such as vases, shall be placed on the radio.
- It is recommended to operate the product such that there is a minimum distance (10cm recommended) to adjacent objects in order to ensure good ventilation.
- The ventilation of the product should not be restricted by covering it or its ventilation openings with items such as newspapers, tablecloths, curtains etc.
- No naked flame sources such as lighted candles should be placed on the product.
- It is recommended to avoid using or storing the product at extremes of temperature. Avoid leaving the unit in cars, on window sills, in direct sunlight etc.
- The product must be used in a moderate climate.

Circuit Features

Loudspeaker 76mm

Headphone socket 3.5mm dia.

Output Power 700mW

Aerial System FM Telescopic aerial
DAB Telescopic aerial

The Company reserves the right to amend the specification without notice

Guarantee

This product is guaranteed for twenty four months from the date of purchase by the original owner against failure due to faulty workmanship or component breakdown, subject to the procedure stated below. Should any component or part fail during this guarantee period it will be repaired or replaced free of charge.

The guarantee does not cover:

1. Damage resulting from incorrect use.
2. Consequential damage.
3. Product with removed or defaced serial numbers.

N.B. Damaged or broken telescopic aerials will not be replaced under guarantee.

Procedure:

Any claim under this guarantee should be made through the dealer from whom the product was purchased. It is likely that your Roberts dealer will be able to attend to any defect quickly and efficiently, but should it be necessary the dealer will return the product to the company's service department for attention. In the event that it is not possible to return the product to the Roberts dealer from whom it was purchased, please contact Roberts Radio using the contact details on the www.robertsradio.com website.

For product repairs falling outside the guarantee period, please refer to the "customer care" tab on the www.robertsradio.com website.

These statements do not affect the statutory rights of a consumer.

ROBERTS RADIO LIMITED

PO Box 130
Mexborough
South Yorkshire
S64 8YT

Website: <http://www.robertsradio.com>

